

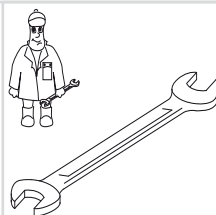

Gebr. Becker GmbH
Hölker Feld 29-31
D-42279 Wuppertal

Wartung
Maintenance
Entretien
Manutenzione
Mantenimiento



	Pos.	Menge ²⁾ Quantity Quantité Quantità Cantidad	Bestell-Nr. Ident No. No. Identification No. Identificazione No. de pedido	Bezeichnung Description Designation Designazione Descripción
KVT 3.140	...	1	549000 21300	Dichtungssatz, Complete set of seals, Jeu de joints, Kit di guarnizioni, Junta completa
	11	SATZ (KIT)	901334 00004	Schieber, Rotor Vane, Palette, Empujador
	11	SATZ (KIT)	901381 00004	" (KVT 3.140/6)
	68	2	909507 00000	Filterpatrone, Filter cartridge, Cartouche Filtrante, Cartuccia filtro, Cartucho de filtro
	68	1	"	" (KVT 3.140/6)
	69	1	909587 00000	" (KVT 3.140/6) - Polyester
91	1	909514 00000	Filterpatrone, Filter cartridge, Cartouche Filtrante, Cartuccia filtro, Cartucho de filtro	

²⁾ erforderliche Bestellmenge / necessary order quantity / quantité nécessaire / quantità di ordinazione necessari / cantidad necesario



Ersatzteilliste
Spare parts list
Liste de pièces de rechange
Listino pezzi di ricambio
Lista de piezas de recambio
Lista de peças sobresselentes
Reserveonderdelenlijst
Reservedelsliste
Reservdelslista

Reservedelsliste
Varaosaluettelo
Wykaz części zamiennych
Seznam náhradních dílů
Tartalékalkatrész lista
Κατάλογος ανταλλακτικών
Перечень запасных частей
备用零件目录
スペアパーツリスト

KVT 3.140



28000021302 07/2010

Index-D

<p>SERVICE</p>	<p>D-42279 Wuppertal www.becker-international.com</p>	year <input type="text" value="XXXX"/> No <input type="text" value="D"/>	Index Option
	CE	type <input type="text" value="KVT 3.140-XX"/>	
	frequency <input type="text" value="XXXX"/> Hz	speed <input type="text" value="XXXX"/> min ⁻¹	
	power required <input type="text" value="XXXX"/> kW	inlet capacity <input type="text" value="XXXX"/> m ³ /h	
	max. vacuum <input type="text" value="XXXX"/> mbar	Made in <input type="text" value="Germany"/>	

D Service:
Tel: +49 (0)202 697-171
Fax: +49 (0)202 64 44 74
E-Mail: info@becker-international.com
 www.becker-international.com



KVT 3.140

Pos.	Bestell Nr.	Beschreibung	
...	549000 21300	DICHTUNGSSATZ ¹⁾	
6	000101 21300	GEHÄUSE	
9	020004 21300	KOLBEN	
11	901334 00004	SCHIEBER (SATZ) ²⁾	
15	000801 21300	SEITENDECKEL LINKS	
16	000701 21300	SEITENDECKEL RECHTS	
17	025512 21300	DICHTUNG	
18	001101 21300	LAGERDECKEL	
19	001006 21300	LAGERDECKEL	
20	025513 21300	DICHTUNG	
24	911305 00000	DICHTUNGSSCHLAUCH	
25	917159 00000	AUSGLEICHSCHEIBE	
26	906544 00000	WELLENDICHRING	
27	906621 00000	WÄLZLAGER 3206/C3	
28	906664 00000	WÄLZLAGER NU 206/ZS	
30	511400 10400	SATZ DISTANZSCHEIBEN	
38	016801 21300	SPANNSCHEIBE	
39	949807 00000	SENKSCRAUBE	
41	945224 00000	SECHSKANTSCHRAUBE	
42	945218 00000	SECHSKANTSCHRAUBE	
43	901804 00000	SECHSKANTSCHRAUBE	
45	948742 00000	PASSKERBSTIFT	
47	947736 00000	PASSFEDER	
50	053201 21300	LATERNE	
52	950308 00000	UNTERLEGSCHNEIBE	
53	945331 00000	INNENSECHSKANTSCHRAUBE	
56	544501 21300	KUPPLUNGSHÄLFTE MIT VENTILATOR	
57	949409 00000	UNTERLEGSCHNEIBE	
58	945270 00000	WELLENENDSCHRAUBE	
61	040102 21300	FILTERGEHÄUSE	
62	025501 21300	DICHTUNG	
64	951009 00000	STIFTSCHRAUBE	
65	951003 00000	STIFTSCHRAUBE	
67	964407 00000	SCHALLDÄMPFERROHR	
68	909507 00000	FILTERPATRONE C 1112/2 (2x) ²⁾	
71	009000 27000	ANPRESSFEDER	
72	948750 00000	BLINDNIET	
73	040204 21300	FILTERDECKEL	
75	025518 21300	DICHTUNG	
76	025516 21100	DICHTUNG	
77	022802 21100	FILTERTRÄGER	
79	945320 00000	INNENSECHSKANTSCHRAUBE	
81	947504 00000	UNTERLEGSCHNEIBE	
83	952019 00000	SPANNHÜLSE	
91	909514 00000	FILTERPATRONE C 718 (1x) ²⁾	
93	903800 70000	STIFTSCHRAUBE	
94	947105 00000	SECHSKANTMUTTER	
95	949450 00000	UNTERLEGSCHNEIBE	
97	950304 00000	UNTERLEGSCHNEIBE	
98	945321 00000	INNENSECHSKANTSCHRAUBE	
103	068801 21300	STAUBABSCHIEDERDECKEL	
104	025515 21300	DICHTUNG	
110	921500 50000	HANDGRIFF	
121	560204 21300	KÜHLER	
122	025506 21300	DICHTUNG	
123	066802 21300	DRUCKANSCHLUSSKASTEN	
125	025504 21300	DICHTUNG	
126	025514 21300	DICHTUNG	
131	948021 00000	DICHTRING	
132	945374 00000	INNENSECHSKANTSCHRAUBE	



KVT 3.140

Pos.	Bestell Nr.	Beschreibung	
137	945322 00000	INNENSECHSKANTSCHRAUBE	
142	016605 21300	ANSCHLUSSLEISTE	
146	025507 21300	DICHTUNG	
148	945364 00000	INNENSECHSKANTSCHRAUBE	
149	741310 30000	GUMMIPUFFER	
161	918300 21300	ABDECKHAUBE	
163	920800 21300	LUFTLEITHAUBE	
165	960700 21300	LÜFTERHAUBE	
166	960701 21300	LÜFTERHAUBE	
171	945371 00000	INNENSECHSKANTSCHRAUBE	
172	945372 00000	INNENSECHSKANTSCHRAUBE	
173	949806 00000	SENKSCRAUBE	
174	951703 00000	FEDERSCHNEIBE	
176	741302 00000	GUMMIPUFFER	
177	945634 00000	GEWINDESTIFT	
178	948802 00000	RINGSCHRAUBE	
181	014902 21300	ZWISCHENFLANSCH	
184	951916 00000	KABELTÜLLE	
185	948772 00000	ROHRNIETE	
186	947508 00000	UNTERLEGSCHNEIBE	
188	945335 00000	INNENSECHSKANTSCHRAUBE	
190	951018 00000	STIFTSCHRAUBE	
192	947506 00000	UNTERLEGSCHNEIBE	
193	947106 00000	SECHSKANTMUTTER	
197	902108 00000	KUPPLUNGSHÄLFTE (MOT)	
199	902210 00000	KUPPLUNGSSCHNEIBE	
241	012200 21300	LEITUNG	
244	912300 00000	ANSCHLUSSCHRAUBE	
245	009400 19000	KUGELSTÜCKSCHRAUBE	
247	948074 00000	DICHTRING	
250	949002 00000	TRICHTERSCHMIERNIPPEL	
342	736001 99624	VAKUUMREGULIERVENTIL	
356	727510 99323	ABBLASEVENTIL	



LAGERFETT 743303 00000 AMBLYGON TA15/2 (FETTPRESSE, 50g)

¹⁾ Dichtungssatz - 54900021300 - Pos.: 17, 20, 24, 62, 75, 76, 86, 104, 122, 125, 126, 146

²⁾ erforderliche Bestellmenge / Wartung

OPTIONAL

KVT 3.140	USA	alle Ausführungen
	/6	Sonderausführung - Korrosionsschutz
	/0-54	Sonderausführung - Abluft-Umleitung
	/6-54	Sonderausführung - Abluft-Umleitung + Korrosionsschutz
	/6-59	Sonderausführung - Abluft-Umleitung + Korrosionsschutz

Abweichende Positionen zum Standardgerät - siehe Anhang (Zeichnungsrückseite)





KVT 3.140

Pos.	Ident No.	Description
...	549000 21300	COMPLETE SET OF SEALS ¹⁾
6	000101 21300	PUMP BODY
9	020004 21300	ROTOR
11	901334 00004	CARBON VANES (KIT) ²⁾
15	000801 21300	LID -LEFT
16	000701 21300	LID RIGHT
17	025512 21300	GASKET
18	001101 21300	BEARING COVER
19	001006 21300	BEARING COVER
20	025513 21300	GASKET
24	911305 00000	SEAL
25	917159 00000	COMPENSATING DISC
26	906544 00000	SHAFT-SEALING RING
27	906621 00000	BALL BEARING
28	906664 00000	BALL BEARING
30	511400 10400	SET DISTANCE DISC
38	016801 21300	CLAMPING DISC
39	949807 00000	SCREW
41	945224 00000	HEX-HEAD SCREW
42	945218 00000	HEX-HEAD SCREW
43	901804 00000	HEX-HEAD SCREW
45	948742 00000	STRAIGHT PIN
47	947736 00000	KEY
50	053201 21300	CONNECTION FLANGE
52	950308 00000	WASHER
53	945331 00000	SOCKET HEAD SCREW
56	544501 21300	COUPLING WITH FAN
57	949409 00000	WASHER
58	945270 00000	SHAFT END BOLD
61	040102 21300	FILTER HOUSING
62	025501 21300	GASKET
64	951009 00000	STUD
65	951003 00000	STUD
67	964407 00000	SILENCER TUBE
68	909507 00000	FILTER CARTRIDGE C 1112/2 (2x) ²⁾
71	009000 27000	LEAF SPRING
72	948750 00000	BLIND RIVET
73	040204 21300	FILTER COVER
75	025518 21300	GASKET
76	025516 21100	GASKET
77	022802 21100	FILTER HOLDER
79	945320 00000	SOCKET HEAD SCREW
81	947504 00000	WASHER
83	952019 00000	LOCATING PEG
91	909514 00000	FILTER CARTRIDGE C 718 (1x) ²⁾
93	903800 70000	STUD
94	947105 00000	HEX.NUT
95	949450 00000	WASHER
97	950304 00000	WASHER
98	945321 00000	SOCKET HEAD SCREW
103	068801 21300	DUST SEPARATOR COVER
104	025515 21300	GASKET
110	921500 50000	HANDLE
121	560204 21300	COOLER
122	025506 21300	GASKET
123	066802 21300	PRESSURE CONNECTION BOX
125	025504 21300	GASKET
126	025514 21300	GASKET
131	948021 00000	SEALING RING
132	945374 00000	SOCKET HEAD SCREW



KVT 3.140

Pos.	Ident No.	Description
137	945322 00000	SOCKET HEAD SCREW
142	016605 21300	CONNECTING PIECE
146	025507 21300	GASKET
148	945364 00000	SOCKET HEAD SCREW
149	741310 30000	RUBBER BUFFER
161	918300 21300	COVERING HOOD
163	920800 21300	AIR GUIDE HOOD
165	960700 21300	VENTILATOR HOOD
166	960701 21300	VENTILATOR HOOD
171	945371 00000	SOCKET HEAD SCREW
172	945372 00000	SOCKET HEAD SCREW
173	949806 00000	SCREW
174	951703 00000	SPRING DISC
176	741302 00000	RUBBER BUFFER
177	945634 00000	THREADED PIN
178	948802 00000	RING SCREW
181	014902 21300	FLANGE
184	951916 00000	RUBBER BUSHING
185	948772 00000	PIPE RIVET
186	947508 00000	WASHER
188	945335 00000	SOCKET HEAD SCREW
190	951018 00000	STUD
192	947506 00000	WASHER
193	947106 00000	HEX.NUT
197	902108 00000	COUPLING
199	902210 00000	COUPLING DISC
241	012200 21300	OIL-PIPE
244	912300 00000	CONNECTING SCREW
245	009400 19000	HOLLOW HOLDING SCREW
247	948074 00000	SEALING RING
250	949002 00000	GREASE NIPPLE
342	736001 99624	VACUUM REGULATING VALVE
356	727510 99323	BLOW-OFF VALVE



GREASE 743303 00000 AMBLYGON TA15/2 (GREASE PRESS, 50g)

¹⁾ Set of seals - 54900021300 - Pos.: 17, 20, 24, 62, 75, 76, 86, 104, 122, 125, 126, 146

²⁾ necessary order quantity / maintenance

OPTIONAL

KVT 3.140	USA	all types
/6		Special design - corrosion protection
/0-54		Special design - exhaust air rear guide
/6-54		Special design - exhaust air rear guide + corrosion protection
/6-59		Special design - exhaust air rear guide + corrosion protection

Items different from standard appliance see appendix (back of drawing) 



KVT 3.140

Pos.	No. Identification	Designation
...	549000 21300	JEU COMPLET DE JOINTS ¹⁾
6	000101 21300	CORP DE POMPE
9	020004 21300	PISTON
11	901334 00004	PALETTE DE CHARBON (KIT) ²⁾
15	000801 21300	COUVERCLE A GAUCHE
16	000701 21300	COUVERCLE A DROITE
17	025512 21300	JOINT
18	001101 21300	COUVERCLE DE ROULEMENTE
19	001006 21300	COUVERCLE DE ROULEMENTE
20	025513 21300	JOINT
24	911305 00000	JOINT
25	917159 00000	DISQUE DE COMPENSATION
26	906544 00000	BAGUE D'ETANCHEITE P.L'AXE
27	906621 00000	ROULEMENT A BILLES
28	906664 00000	ROULEMENT A BILLES
30	511400 10400	JEU DISQUE DE TOLERANCE
38	016801 21300	DISQUE DE SERRAGE
39	949807 00000	VIS
41	945224 00000	VIS HEXAGONALE
42	945218 00000	VIS HEXAGONALE
43	901804 00000	VIS HEXAGONALE
45	948742 00000	GOUPILLE CYLINDRIQUE
47	947736 00000	CLAVETTE
50	053201 21300	BRIDE DE RACCORDEMENT
52	950308 00000	RONDELLE
53	945331 00000	VIS HEXAGONALE INTERNE
56	544501 21300	ACCOUPLLEMENT AVEC VENTILATEUR
57	949409 00000	RONDELLE
58	945270 00000	VIS BOUT D'ARBRE
61	040102 21300	BOITE POUR FILTRE
62	025501 21300	JOINT
64	951009 00000	PRISONNIER
65	951003 00000	PRISONNIER
67	964407 00000	TUBE SILENCIEUX
68	909507 00000	CARTOUCHE FILTRANTE C 1112/2 (2x) ²⁾
71	009000 27000	RESSORT-JAME
72	948750 00000	RIVET AVEUGLIE
73	040204 21300	COUVERCLE DE FILTRE
75	025518 21300	JOINT
76	025516 21100	JOINT
77	022802 21100	SUPPORT FILTRE
79	945320 00000	VIS HEXAGONALE INTERNE
81	947504 00000	RONDELLE
83	952019 00000	DOUILLE DE ETRAGE
91	909514 00000	CARTOUCHE FILTRANTE C 718 (1x) ²⁾
93	903800 70000	PRISONNIER
94	947105 00000	ECROU A 6 PANS
95	949450 00000	RONDELLE
97	950304 00000	RONDELLE
98	945321 00000	VIS HEXAGONALE INTERNE
103	068801 21300	COUVERCLE
104	025515 21300	JOINT
110	921500 50000	POIGNEE
121	560204 21300	REFROIDISSEUR
122	025506 21300	JOINT
123	066802 21300	BOITIER DE RACCORD DE REFOULEMENT
125	025504 21300	JOINT
126	025514 21300	JOINT
131	948021 00000	JOINT
132	945374 00000	VIS HEXAGONALE INTERNE



KVT 3.140

Pos.	No. Identification	Designation
137	945322 00000	VIS HEXAGONALE INTERNE
142	016605 21300	PIECE RACCORD
146	025507 21300	JOINT
148	945364 00000	VIS HEXAGONALE INTERNE
149	741310 30000	AMORTISSEUR EN CAOUTCHOUC
161	918300 21300	CARTER
163	920800 21300	CAPOT DE CANALISATION DE L'AIR
165	960700 21300	CARTER DE VENTILATEUR
166	960701 21300	CARTER DE VENTILATEUR
171	945371 00000	VIS HEXAGONALE INTERNE
172	945372 00000	VIS HEXAGONALE INTERNE
173	949806 00000	VIS À TÊTE NOYÉE
174	951703 00000	DISQUE DE RESSORT
176	741302 00000	AMORTISSEUR EN CAOUTCHOUC
177	945634 00000	GOUPILLE FILETEE
178	948802 00000	PITON
181	014902 21300	BRIDE
184	951916 00000	PROTECTION EN CAOUTCHOUC
185	948772 00000	RIVET TUBE
186	947508 00000	RONDELLE
188	945335 00000	VIS HEXAGONALE INTERNE
190	951018 00000	PRISONNIER
192	947506 00000	RONDELLE
193	947106 00000	ECROU A 6 PANS
197	902108 00000	ACCOUPLLEMENT
199	902210 00000	DISQUE D'ACCOUPLLEMENT
241	012200 21300	TUYEAU DE GRAISSAGE
244	912300 00000	VIS DE RACCORD
245	009400 19000	VIS CREUSE DE FIXATION
247	948074 00000	JOINT
250	949002 00000	GRAISSEUR
342	736001 99624	SOUPAPE REGULAGE VIDE
356	727510 99323	SOUPAPE D'ÉCHAPPEMENT



GRAISSE 743303 00000 AMBLYGON TA15/2 (POMPE À GRAISSE, 50g)

¹⁾ Jeu de joints - 54900021300 - Pos.: 17, 20, 24, 62, 75, 76, 86, 104, 122, 125, 126, 146

²⁾ quantité nécessaire / entretien

EN OPTION

KVT 3.140	USA	Tous les fabrication
/6		Fabrication spéciale – protection contre la corrosion
/0-54		Fabrication spéciale – guide de derrière / air évacué
/6-54		Fabrication spéciale – guide de derrière / air évacué + protection contre la corrosion
/6-59		Fabrication spéciale – guide de derrière / air évacué + protection contre la corrosion

Articles divergents vis-à-vis de l'appareil standard, voir annexe (dos du dessin / du plan)

**KVT 3.140**

Pos.	No. Identificazione	Designazione
...	549000 21300	SERIE COMPLETA DI GUARNIZIONE ¹⁾
6	000101 21300	CARCASSA
9	020004 21300	ROTORE
11	901334 00004	PALETTE DI CHARBONE (KIT) ²⁾
15	000801 21300	COPERCHIO SINISTRA
16	000701 21300	COPERCHIO DESTRA
17	025512 21300	GUARNIZIONE
18	001101 21300	COPERCHIO CUSCINETTO
19	001006 21300	COPERCHIO CUSCINETTO
20	025513 21300	GUARNIZIONE
24	911305 00000	GUARNIZIONE
25	917159 00000	DISCO COMPENSATORE
26	906544 00000	GUARNIZIONE PER L'ALBERO
27	906621 00000	CUSCINETTO A SFERA
28	906664 00000	CUSCINETTO A SFERA
30	511400 10400	SERIE DISCO GIUOCO
38	016801 21300	DISCO DI FISSAGGIO
39	949807 00000	VITE
41	945224 00000	VITE ESAGONALE
42	945218 00000	VITE ESAGONALE
43	901804 00000	VITE ESAGONALE
45	948742 00000	PERNO
47	947736 00000	CHIAVETTA
50	053201 21300	FLANGIA DI RACCORDE
52	950308 00000	RONDELLA
53	945331 00000	VITE ESAGONALE INTERNA
56	544501 21300	GIUNTO CON VENTILATORE
57	949409 00000	RONDELLA
58	945270 00000	VITE DI CHIUSURA ALBERO
61	040102 21300	CONTENITORE FILTRO
62	025501 21300	GUARNIZIONE
64	951009 00000	L'ASTA A VITE
65	951003 00000	L'ASTA A VITE
67	964407 00000	TUBO SILENZIATORE
68	909507 00000	CARTUCCIA FILTRO C 1112/2 (2x) ²⁾
71	009000 27000	MOLLA
72	948750 00000	RIVETTO CIECO
73	040204 21300	COPERCHIO FILTRO
75	025518 21300	GUARNIZIONE
76	025516 21100	GUARNIZIONE
77	022802 21100	SUPPORTO FILTRO
79	945320 00000	VITE ESAGONALE INTERNA
81	947504 00000	RONDELLA
83	952019 00000	SPINE DI RISCONTRO
91	909514 00000	CARTUCCIA FILTRO C 718 (1x) ²⁾
93	903800 70000	L'ASTA A VITE
94	947105 00000	DADO ESAGONALE
95	949450 00000	RONDELLA
97	950304 00000	RONDELLA
98	945321 00000	VITE ESAGONALE INTERNA
103	068801 21300	COPERCHIO
104	025515 21300	GUARNIZIONI
110	921500 50000	MANETTA
121	560204 21300	RAFFREDDATORE
122	025506 21300	GUARNIZIONE
123	066802 21300	SCATOLA DI RACCORDO DI MANDATA
125	025504 21300	GUARNIZIONE
126	025514 21300	GUARNIZIONI
131	948021 00000	ANELLO GUARNIZIONE
132	945374 00000	VITE ESAGONALE INTERNA

**KVT 3.140**

Pos.	No. Identificazione	Designazione
137	945322 00000	VITE ESAGONALE INTERNA
142	016605 21300	PEZZI RACCORDI
146	025507 21300	GUARNIZIONE
148	945364 00000	VITE ESAGONALE INTERNA
149	741310 30000	AMMORTIZZATORE IN GOMMA
161	918300 21300	CARTER
163	920800 21300	CAPPOTTA DEL CONDOTTA ARIA
165	960700 21300	CARTER VENTILATORE
166	960701 21300	CARTER VENTILATORE
171	945371 00000	VITE ESAGONALE INTERNA
172	945372 00000	VITE ESAGONALE INTERNA
173	949806 00000	VITE A TESTA SVASATA
174	951703 00000	DISCO A MOLLA
176	741302 00000	AMMORTIZZATORE IN GOMMA
177	945634 00000	SPINA FILETTATURA
178	948802 00000	GANCIO
181	014902 21300	FLANGIA
184	951916 00000	PROTEZIONE IN GOMMA
185	948772 00000	CHiodo TUBOLARE
186	947508 00000	RONDELLA
188	945335 00000	VITE ESAGONALE INTERNA
190	951018 00000	L'ASTA A VITE
192	947506 00000	RONDELLA
193	947106 00000	DADO ESAGONALE
197	902108 00000	GIUNTO
199	902210 00000	DISCO GIUNTO
241	012200 21300	CONDOTTO
244	912300 00000	ATTACO FILETTATO
245	009400 19000	VITE PASSAGGIO OLIO
247	948074 00000	ANELLO GUARNIZIONE
250	949002 00000	RACCORDO DI LUBRIFICAZIONE
342	736001 99624	VALVOLA REGOLAZIONE VUOTO
356	727510 99323	VALVOLA DI SFIATO



GRASSO 743303 00000 AMBLYGON TA15/2 (INGRASSATORE A PISTOLA, 50g)

¹⁾ Serie di guarnizione - 54900021300 - Pos.: 17, 20, 24, 62, 75, 76, 86, 104, 122, 125, 126, 146

²⁾ quantità di ordinazione necessari / manutenzione

OPZIONALE

KVT 3.140	USA	Tutte tipi
	/6	Modello speciale - protezione anti-corrosione
	/0-54	Modello speciale - guida di ritorno / aria estratta
	/6-54	Modello speciale - guida di ritorno / aria estratta + protezione anti-corrosione
	/6-59	Modello speciale - guida di ritorno / aria estratta + protezione anti-corrosione

Vedere allegato (retro del disegno) per le posizioni divergenti dall'apparecchio standard





KVT 3.140

Pos.	No. De pedido	Descripción
...	549000 21300	JUNTA COMPLETA ¹⁾
6	000101 21300	CARCASA
9	020004 21300	ÉMBOLO, ACABADO
11	901334 00004	EMPUJADOR (KIT) ²⁾
15	000801 21300	TAPA LATERAL
16	000701 21300	TAPA LATERAL DERECHA
17	025512 21300	JUNTA
18	001101 21300	TAPA DE COJINETE
19	001006 21300	TAPA DE COJINETE
20	025513 21300	JUNTA
24	911305 00000	MANGUERA DE JUNTA
25	917159 00000	ARANDELA DE COMPENSACIÓN
26	906544 00000	ANILLO DE JUNTA DE ÁRBOL
27	906621 00000	COJINETE DE RODAMIENTO
28	906664 00000	COJINETE DE RODAMIENTO NU 206/ZS
30	511400 10400	JUEGO DE ARANDELAS DISTANCIADORAS
38	016801 21300	ARANDELA TENSORA
39	949807 00000	TORNILLO AVELLANADO
41	945224 00000	TORNILLO DE CABEZA HEXAGONAL
42	945218 00000	TORNILLO DE CABEZA HEXAGONAL
43	901804 00000	TORNILLO DE CABEZA HEXAGONAL
45	948742 00000	PASADOR ENTALLADO DE AJUSTE
47	947736 00000	LENGÜETA DE AJUSTE
50	053201 21300	FAROL
52	950308 00000	ARANDELA
53	945331 00000	TORNILLO HEXAGONAL INTERIOR
56	544501 21300	MITAD DE ACOPLAMIENTO CON VENTILADOR
57	949409 00000	ARANDELA
58	945270 00000	TORNILLO TERMINAL DE ÁRBOL
61	040102 21300	CARCASA DE FILTRO
62	025501 21300	JUNTA
64	951009 00000	ESPÁRRAGO
65	951003 00000	ESPÁRRAGO
67	964407 00000	TUBO DE SILENCIADOR
68	909507 00000	CARTUCHO DE FILTRO C 1112/2 (2x) ²⁾
71	009000 27000	MUELLE DE PRESIÓN
72	948750 00000	REMACHE CIEGO
73	040204 21300	TAPA DE FILTRO
75	025518 21300	JUNTA
76	025516 21100	JUNTA
77	022802 21100	SOPORTE DE FILTRO
79	945320 00000	TORNILLO HEXAGONAL INTERIOR
81	947504 00000	ARANDELA
83	952019 00000	CASQUILLO TENSOR
91	909514 00000	CARTUCHO DE FILTRO C 718 (1x) ²⁾
93	903800 70000	ESPÁRRAGO
94	947105 00000	TUERCA HEXAGONAL
95	949450 00000	ARANDELA
97	950304 00000	ARANDELA
98	945321 00000	TORNILLO HEXAGONAL INTERIOR
103	068801 21300	TAPA DE SEPARADOR DE POLVO
104	025515 21300	JUNTA
110	921500 50000	EMPUÑADURA
121	560204 21300	REFRIGERADOR
122	025506 21300	JUNTA
123	066802 21300	CAJA DE EMPALME DE PRESIÓN
125	025504 21300	JUNTA
126	025514 21300	JUNTA
131	948021 00000	ANILLO DE JUNTA
132	945374 00000	TORNILLO HEXAGONAL INTERIOR



KVT 3.140

Pos.	No. De pedido	Descripción
137	945322 00000	TORNILLO HEXAGONAL INTERIOR
142	016605 21300	PIEZA DE EMPALME
146	025507 21300	JUNTA
148	945364 00000	TORNILLO HEXAGONAL INTERIOR
149	741310 30000	AMORTIGUADOR DE GOMA
161	918300 21300	CAPERUZA DE RECUBRIMIENTO
163	920800 21300	CAPERUZA CONDUCTOR DE AIRE
165	960700 21300	CAPERUZA DE VENTILADOR
166	960701 21300	CAPERUZA DE VENTILADOR
171	945371 00000	TORNILLO HEXAGONAL INTERIOR
172	945372 00000	TORNILLO HEXAGONAL INTERIOR
173	949806 00000	TORNILLO AVELLANADO
174	951703 00000	ARANDELA ELÁSTICA
176	741302 00000	AMORTIGUADOR DE GOMA
177	945634 00000	VARILLA ROSCADA
178	948802 00000	TORNILLO DE CÁNCAMO
181	014902 21300	BRIDA INTERMEDIA
184	951916 00000	BOQUILLA DE CABLE
185	948772 00000	REMACHE TUBULAR
186	947508 00000	ARANDELA
188	945335 00000	TORNILLO HEXAGONAL INTERIOR
190	951018 00000	ESPÁRRAGO
192	947506 00000	ARANDELA
193	947106 00000	TUERCA HEXAGONAL
197	902108 00000	MITAD DE ACOPLAMIENTO (MOT)
199	902210 00000	DISCO DE ACOPLAMIENTO
241	012200 21300	CONDUCTO
244	912300 00000	TORNILLO DE EMPALME
245	009400 19000	TORNILLO DE PIEZA ESFÉRICA
247	948074 00000	ANILLO DE JUNTA
250	949002 00000	BOQUILLA DE TOLVA DE LUBRICACIÓN
342	736001 99624	VÁLVULA REGULADORA DE VACÍO
356	727510 99323	VÁLVULA DE ESCAPE



GRASA	743303 00000	AMBLYGON TA15/2 (PISTOLA DE GRASA, 50g)
--------------	--------------	---

¹⁾ Junta completa - 54900021300 - Pos.: 17, 20, 24, 62, 75, 76, 86, 104, 122, 125, 126, 146

²⁾ cantidad necesario / mantenimiento

OPCIONAL

KVT 3.140	USA	Versión general
	/6	Versión especial – protección contra la corrosión
	/0-54	Versión especial – guía posterior / aire de extraccion
	/6-54	Versión especial – guía posterior / aire de extraccion + protección contra la corrosión
	/6-59	Versión especial – guía posterior / aire de extraccion + protección contra la corrosión

Para posiciones que derivan del aparato standard véase apéndice (lado trasero del plano)



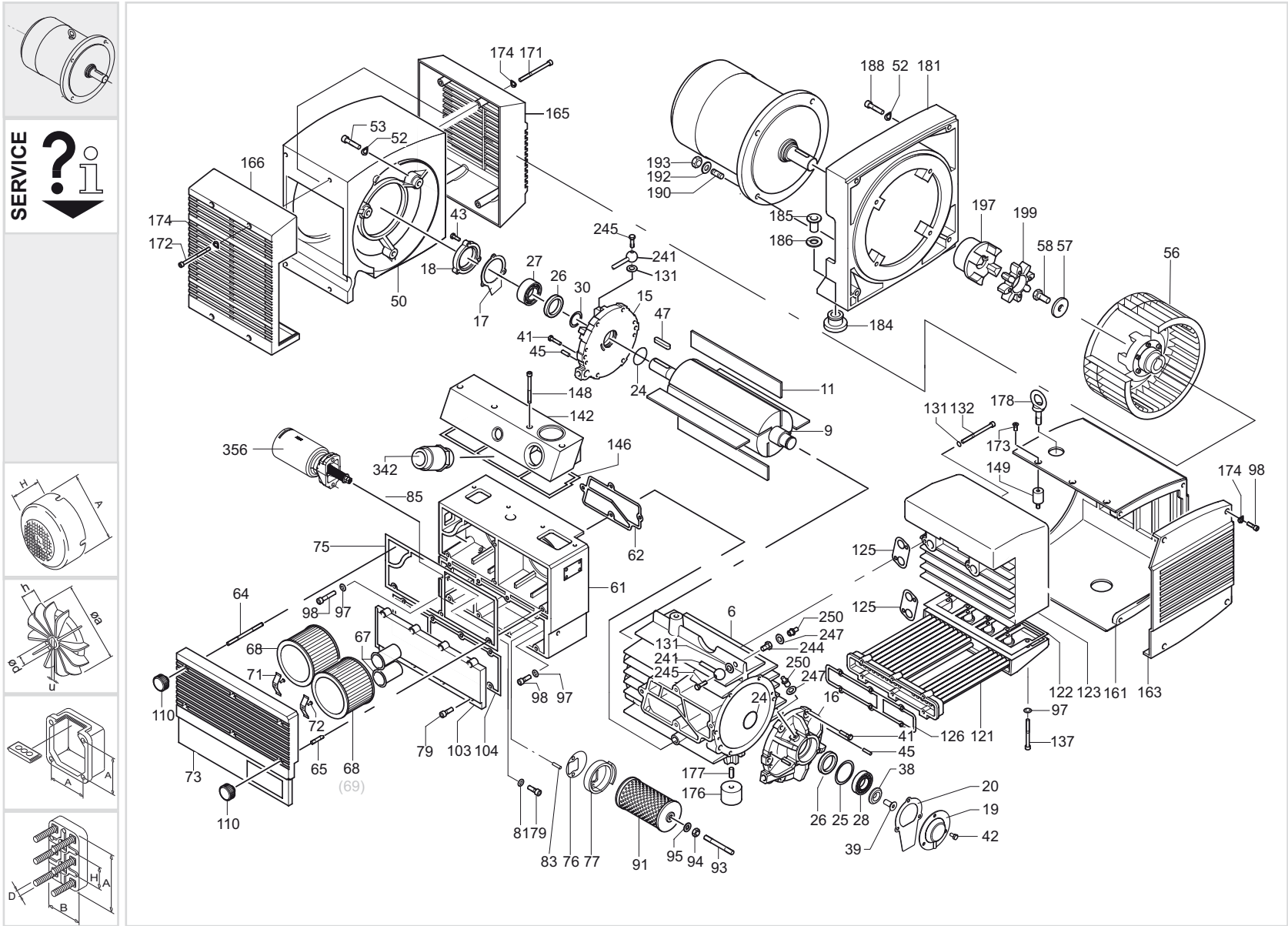





 **standard**

KVT 3.140

optional
en option
opcionale
opcional 

optional en option optionale opcional 	Variante(n) Modifications Variantes	Pos ³⁾	Bestell Nr. / Ident No. / No. Identification / No. Identificazione / No. De pedido		Beschreibung / Description / Designation / Designazione / Descripcion
					
KVT 3.140/XX	KVT 3.140 (USA)	181		014902-21300	ZWISCHENFLANSCH / FLANGE / BRIDE / FLANGIA / BRIDA INTERMEDIA
	(B5 - 300)	197		902108-00000	KUPPLUNGSHÄLFTE / COUPLING / ACCOUPLEMENT / GIUNTO / MITAD DE ACOPLAMIENTO
	(B5 - 250)	233	014903 21300		ZWISCHENFLANSCH / FLANGE / BRIDE / FLANGIA / BRIDA INTERMEDIA
		234	037900 10400		ZWISCHENFLANSCH / FLANGE / BRIDE / FLANGIA / BRIDA INTERMEDIA
		235	902100 21300		KUPPLUNGSHÄLFTE / COUPLING / ACCOUPLEMENT / GIUNTO / MITAD DE ACOPLAMIENTO
	KVT 3.140/0-54	80	946944 00000		STIFTSCHRAUBE / STUD / PRISONNIER / L'ASTA A VITE / ESPÁRRAGO
		82	947104 00000		SECHSKANTMUTTER / HEX.NUT / ECROU A 6 PANS / DADO ESAGONALE / TUERCA HEXAGONAL
		86	025515 21100		DICHTUNG / GASKET / JOINT / GUARNIZIONE / JUNTA
		141	016604 21300		ANSCHLUSSLEISTE / CONNECTING PIECE / PIECE RACCORD / PEZZI RACCORDI / PIEZA DE EMPALME
		142		016605-21300	ANSCHLUSSLEISTE / CONNECTING PIECE / PIECE RACCORD / PEZZI RACCORDI / PIEZA DE EMPALME
	230	019901 21100		UMLENKSTÜCK / RETURN PIECE / PIECE DE RETOUR / PEZZO INVERSIONE / PIEZA DE DESVIACIÓN	
	(B5 - 300)	181	014903 21300	014902-21300	ZWISCHENFLANSCH / FLANGE / BRIDE / FLANGIA / BRIDA INTERMEDIA
	(B5 - 300)	190	951022 00000	951019-00000	STIFTSCHRAUBE / STUD / PRISONNIER / L'ASTA A VITE / ESPÁRRAGO
	(B5 - 300)	198	902100 21900	902108-00000	KUPPLUNGSHÄLFTE / COUPLING / ACCOUPLEMENT / GIUNTO / MITAD DE ACOPLAMIENTO
	KVT 3.140/6	6	000111 21300	000101-21300	GEHÄUSE / PUMP BODY / CORP DE POMPE / CARCASSA / CARCASA
		9	020011 21300	020004-21300	KOLBEN / ROTOR / PISTON / ROTORE / ÉMBOLO
		11	901381 00004	901334-00004	SCHIEBER / ROTOR VANE / PALETTE / PALETTE / EMPUJADOR
		15	000811 21300	000801-21300	SEITENDECKEL-LINKS / LID LEFT / COUVERCLE A GAUCHE / COPERCHIO SINISTRA / TAPA LATERAL
		16	000711 21300	000701-21300	SEITENDECKEL-RECHTS / LID RIGHT / COUVERCLE A DROITE / COPERCHIO DESTRA / TAPA LATERAL DERECHA
		68		909507-00000	FILTERPATRONE (1x) / FILTER CARTRIDGE / CARTOUCHE FILTRE / CARTUCCIA FILTRO / CARTUCHO DE FILTRO
		69	909587 00000		FILTERPATRONE (1x POLYESTER) / FILTER CARTRIDGE / CARTOUCHE FILTRE / CARTUCCIA FILTRO / CARTUCHO DE FILTRO
	 KVT 3.140/6-54 KVT 3.140/6-59	76	02551621100	02280221100	DICHTUNG / GASKET / JOINT / GUARNIZIONE / JUNTA
		77	945321 00000	945320-00000	FILTERTRÄGER / FILTER HOLDER / SUPPORT FILTRE / SUPPORTO FILTRO / SOPORTE DE FILTRO
		79	946944 00000	946944 00000	INNENSECHSKANTSCHRAUBE / SOCKET HEAD SCREW / VIS HEXAGONALE INTERNE / VITE ESAGONALE INTERNA / TORNILLO HEXAGONAL INTERIOR
		80	946944 00000		STIFTSCHRAUBE / STUD / PRISONNIER / L'ASTA A VITE / ESPÁRRAGO
		82	947104 00000		SECHSKANTMUTTER / HEX.NUT / ECROU A 6 PANS / DADO ESAGONALE / TUERCA HEXAGONAL
		83		95201900000	SECHSKANTMUTTER / HEX.NUT / ECROU A 6 PANS / DADO ESAGONALE / TUERCA HEXAGONAL
		86	025515 21100		DICHTUNG / GASKET / JOINT / GUARNIZIONE / JUNTA
		91		909514-00000	FILTERPATRONE / FILTER CARTRIDGE / CARTOUCHE FILTRE / CARTUCCIA FILTRO / CARTUCHO DE FILTRO
		93	946107 00000	903800-70000	STIFTSCHRAUBE / STUD / PRISONNIER / L'ASTA A VITE / ESPÁRRAGO
		94		94710500000	SECHSKANTMUTTER / HEX.NUT / ECROU A 6 PANS / DADO ESAGONALE / TUERCA HEXAGONAL
		95		94945000000	UNTERLEGSCHLEIBE / WASHER / RONDELLE / RONDELLA / ARANDELA
		141	016604 21300		ANSCHLUSSLEISTE / CONNECTING PIECE / PIECE RACCORD / PEZZI RACCORDI / PIEZA DE EMPALME
		142		016605-21300	ANSCHLUSSLEISTE / CONNECTING PIECE / PIECE RACCORD / PEZZI RACCORDI / PIEZA DE EMPALME
		230	019901 21100		UMLENKSTÜCK / RETURN PIECE / PIECE DE RETOUR / PEZZO INVERSIONE / PIEZA DE DESVIACIÓN
		299	951227 00000		VERSCHLUSSSCHRAUBE / SCREW PLUG / BOUCHON FILETÉ / TAPPO A VITE / TAPÓN ROSCADO
		356		727540-99323	ABBLASEVENTIL / BLOW-OFF VALVE / SOUPAPE D'ÉCHAPPEMENT / VALVOLA DI SFILATO / VALVOLA DE ESCAPE

³⁾ variantenabhängige Bauteile / variant-dependent components / composants variante-dependantes / componenti variante-dispendenti / componentes variante-dependientes